

## LZCG530-10

### High-precision Current Transformer

LZCG series high precision current transformer is suitable for current measurement and microcomputer protection of electrical equipment in 10KV and 35KV AC power system. It is widely used in not only compact fully insulated ring network switchgears such as ABB-SafeRing/SafePlus, Uniswitch, Schneider RM6, SM6, Siemens 8DJ10/8DH10, Simosec, FBX, Fluokit, Omar Garbo GA, GAE; SEL TPS(Q); VEI Unifluorc; Eaton SVS/12 ring network, but also cable distribution boxes because of its small size, light weight, openable and convenient installation. It is very convenient that the transformer can be directly installed at the inlet and outlet cables.

New magnetic material is taken to be the core of the current transformer, which has high magnetic permeability, low saturation magnetization and good stability. Therefore, the measuring accuracy is higher and the instrument security factor is lower. Since the high quality silicon processed by advanced technology is taken to be the core of the protection windings, which assured the accuracy limit factor is higher.

The semicircular ring core and secondary windings are vacuum poured by high quality epoxide resin in the fire retardant plastic casing, which has the characteristic of moisture proof, stable performance and dispensing with maintenance. Small size, light weight, small footprint, fixed in the ring network switchgear cable. The cable can cross the current transformer through its internal poles quickly and uniformly.

The current transformers can be divided several kinds according to the various current ratio, accuracy and rated loads. The specific parameters are showed in the corresponding to each model parameter tables.

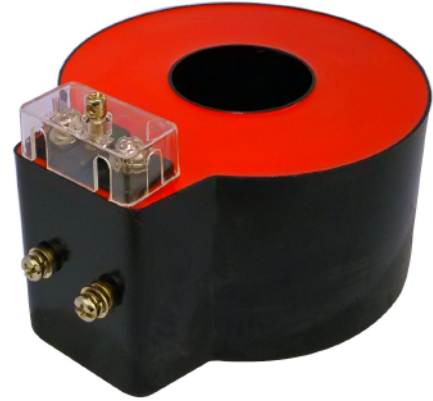

### Outline drawing

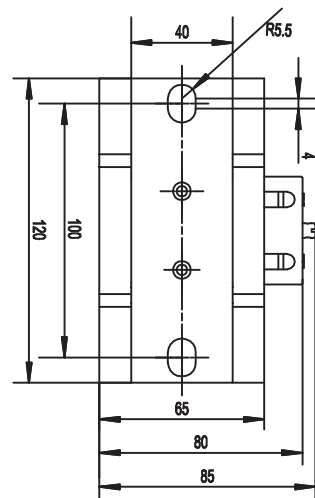
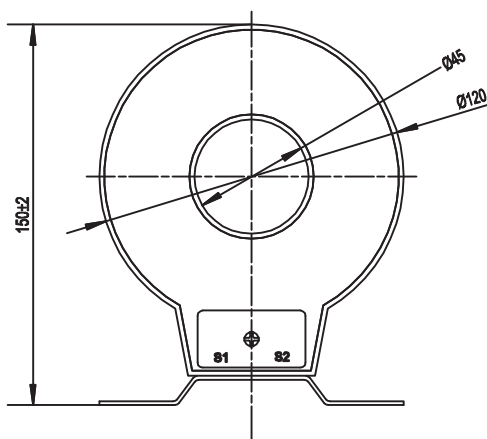

Архангельск (8182)63-90-72  
 Астана (7172)727-132  
 Астрахань (8512)99-46-04  
 Барнаул (3852)73-04-60  
 Белгород (4722)40-23-64  
 Брянск (4832)59-03-52  
 Владивосток (423)249-28-31  
 Волгоград (844)278-03-48  
 Вологда (8172)26-41-59  
 Воронеж (473)204-51-73  
 Екатеринбург (343)384-55-89  
 Иваново (4932)77-34-06

Ижевск (3412)26-03-58  
 Иркутск (395)279-98-46  
 Казань (843)206-01-48  
 Калининград (4012)72-03-81  
 Калуга (4842)92-23-67  
 Кемерово (3842)65-04-62  
 Киров (8332)68-02-04  
 Краснодар (861)203-40-90  
 Красноярск (391)204-63-61  
 Курск (4712)77-13-04  
 Липецк (4742)52-20-81

Магнитогорск (3519)55-03-13  
 Москва (495)268-04-70  
 Мурманск (8152)59-64-93  
 Набережные Челны (8552)20-53-41  
 Нижний Новгород (831)429-08-12  
 Новокузнецк (3843)20-46-81  
 Новосибирск (383)227-86-73  
 Омск (3812)21-46-40  
 Орел (4862)44-53-42  
 Оренбург (3532)37-68-04  
 Пенза (8412)22-31-16

Пермь (342)205-81-47  
 Ростов-на-Дону (863)308-18-15  
 Рязань (4912)46-61-64  
 Самара (846)206-03-16  
 Санкт-Петербург (812)309-46-40  
 Саратов (845)249-38-78  
 Севастополь (8692)22-31-93  
 Симферополь (3652)67-13-56  
 Смоленск (4812)29-41-54  
 Сочи (862)225-72-31  
 Ставрополь (8652)20-65-13

Сургут (3462)77-98-35  
 Тверь (4822)63-31-35  
 Томск (3822)98-41-53  
 Тула (4872)74-02-29  
 Тюмень (3452)66-21-18  
 Ульяновск (8422)24-23-59  
 Уфа (347)229-48-12  
 Хабаровск (4212)92-98-04  
 Челябинск (351)202-03-61  
 Череповец (8202)49-02-64  
 Ярославль (4852)69-52-93

Киргизия (996)312-96-26-47

Россия (495)268-04-70

Казахстан (772)734-952-31

## Model meaning

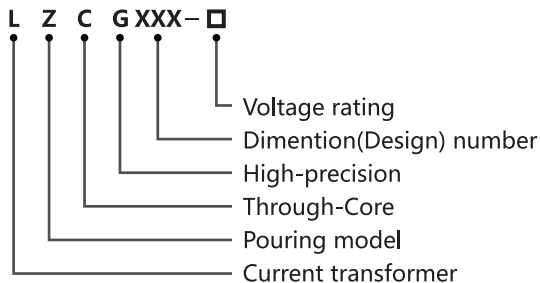

## Wiring diagrams

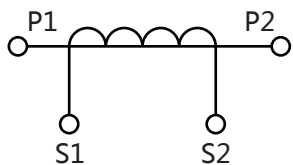

Single winding

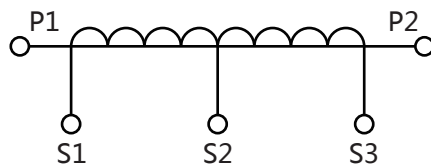

Secondary winding with tap

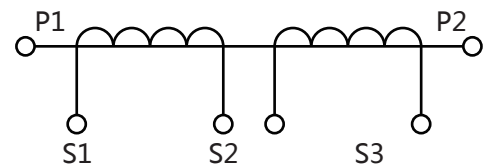

Double winding

P1, P2 is primary polarity terminal, S1, S2 is secondary polarity terminal.  
 P2, S2 is homonymous terminals (subtractive polarity).

## Parameters

Technical parameters	
Standards	IEC60044-1; IEC 61869-2; NTC 2205; GB1208-2006
Rated primary current	30-600A
Rated load	≤20VA
Rated frequency	50Hz or 60Hz
Rated secondary current	5A or 1A
Rated short-time thermal current	40kA, 1S
Rated continuous thermal current	120%I <sub>1n</sub>
Secondary winding power-frequency voltage	3kV, 1min
Instrument security factor	FS ≤10
Mechanical parameters	
Dimensions (W×D×H) (mm)	φ45×φ120×65
Weight (kg)	5
Operating conditions	
Operating temperature	-35°C to +55°C
Daily average temp	<+40°C
Altitude	<3500 meters

## Operating conditions - continued

Condition	No existence of severely begrimed, erosive and radioactive gas in the air. Permission of long-term operation under rated current.
-----------	---

## Technical data

Type	LZCG530-10			LZCG530-10			LZCG530-10			
Purpose	Measuring current transformer			Protection current transformer			Double winding current transformer			
Rated primary current (AMP)	Accuracy class and rated load(VA)			Accuracy class and rated load(VA)			Composite accuracy class and rated load(VA)			
	0.2S	0.2	0.5	10P20	10P15	10P10	0.2S	0.5	10P15	10P10
30			2							
40			2.5							
50			3.75			2				
75		3.75	5		2	3.75				
100	2.5	5	7.5		2.5	3.75				
150	5	7.5	10	2.5	3.75	6.25	2.5	3.75		2.5
200	7.5	10	15	3.75	5	7.5	5	7.5		3.75
300	10	15	20	5	7.5	10	7.5	10	2.5	5
400	15	20	25	6.25	7.5	15	10	12.5	3.75	5
500	20	25	25	6.25	7.5	15	15	15	3.75	5
600	20	30	30	7.5	10	20	15	20	3.75	7.5

## Selection guide

Model	Primary rated current	Rated load	Aperture (mm)	Description (mm)	Weight (kg)	Material	Water-proof
LMCK055-10	300-1200A	≤10VA	φ55	180×138×52	2	PC	IP65
LMCK185-10	300-3000A	≤25VA	φ185	350×283×55	4.5	PC	IP65
LZCK310-10	300-600A	≤10VA	φ50	φ50 x φ110 x 32	1	Resin	silicon case (option)
LZCK322-10	30-600A	≤10VA	φ50	φ50 x φ110 x 52	1.6	Resin	silicon case (option)
LZCK350-10	20-600A	≤25VA	φ50	φ50 x φ110 x 105	3.1	Resin	silicon case (option)
LZCG530-10	30-600A	≤20VA	φ45	φ45 x φ120 x 65	5	Resin	silicon case (option)

Архангельск (8182)63-90-72  
Астана (7172)727-132  
Астрахань (8512)99-46-04  
Барнаул (3852)73-04-60  
Белгород (4722)40-23-64  
Брянск (4832)59-03-52  
Владивосток (423)249-28-31  
Волгоград (844)278-03-48  
Вологда (8172)26-41-59  
Воронеж (473)204-51-73  
Екатеринбург (343)384-55-89  
Иваново (4932)77-34-06

Ижевск (3412)26-03-58  
Иркутск (395)279-98-46  
Казань (843)206-01-48  
Калининград (4012)72-03-81  
Калуга (4842)92-23-67  
Кемерово (3842)65-04-62  
Киров (8332)68-02-04  
Краснодар (861)203-40-90  
Красноярск (391)204-63-61  
Курск (4712)77-13-04  
Липецк (4742)52-20-81

Магнитогорск (3519)55-03-13  
Москва (495)268-04-70  
Мурманск (8152)59-64-93  
Набережные Челны (8552)20-53-41  
Нижний Новгород (831)429-08-12  
Новокузнецк (3843)20-46-81  
Новосибирск (383)227-86-73  
Омск (3812)21-46-40  
Орел (4862)44-53-42  
Оренбург (3532)37-68-04  
Пенза (8412)22-31-16

Пермь (342)205-81-47  
Ростов-на-Дону (863)308-18-15  
Рязань (4912)46-61-64  
Самара (846)206-03-16  
Санкт-Петербург (812)309-46-40  
Саратов (845)249-38-78  
Севастополь (8692)22-31-93  
Симферополь (3652)67-13-56  
Смоленск (4812)29-41-54  
Сочи (862)225-72-31  
Ставрополь (8652)20-65-13

Сургут (3462)77-98-35  
Тверь (4822)63-31-35  
Томск (3822)98-41-53  
Тула (4872)74-02-29  
Тюмень (3452)66-21-18  
Ульяновск (8422)24-23-59  
Уфа (347)229-48-12  
Хабаровск (4212)92-98-04  
Челябинск (351)202-03-61  
Череповец (8202)49-02-64  
Ярославль (4852)69-52-93

Киргизия (996)312-96-26-47

Россия (495)268-04-70

Казахстан (772)734-952-31

<https://gfuve.nt-rt.ru/> || [gfv@nt-rt.ru](mailto:gfv@nt-rt.ru)